

Product Details

Every day is sunny day

Item No.	SG14122428
Material	high white glass material
Process	Machine made
Samples time	1. 5 days if at exist shaped and size of glass 2. 15 days if need new shape or size of glass
Packing	Normal packing,4 pcs into inner box, 48 pcs per carton
Product Capacity	500,000~1,000,000 pcs per month
Delivery time	Within 35 days after the sample and order confirmed
Payment terms	30% deposit by T/T in advance and the balance against the copy of B/L
Shipment	By sea, by air, by Express and your shipping agent is acceptable
Product Features	1. Machine made glass candle holder with high quality 2. Suitable for used in hotel, home, etc. 3. It is eco-friendly 4. Meet FDA test & CA 65 test
For your choices	1. Different designs and sizes for choice 2. Any color painted, frost, electroplate, pattern laser carver processing 3. Special package like shrink wrap, color gift box, white gift box etc. 4. We have exclusive workers for quality control 5. We have professional workshop and warehouse to ensure the delivery time

More Product Pictures

Every day is sunny day



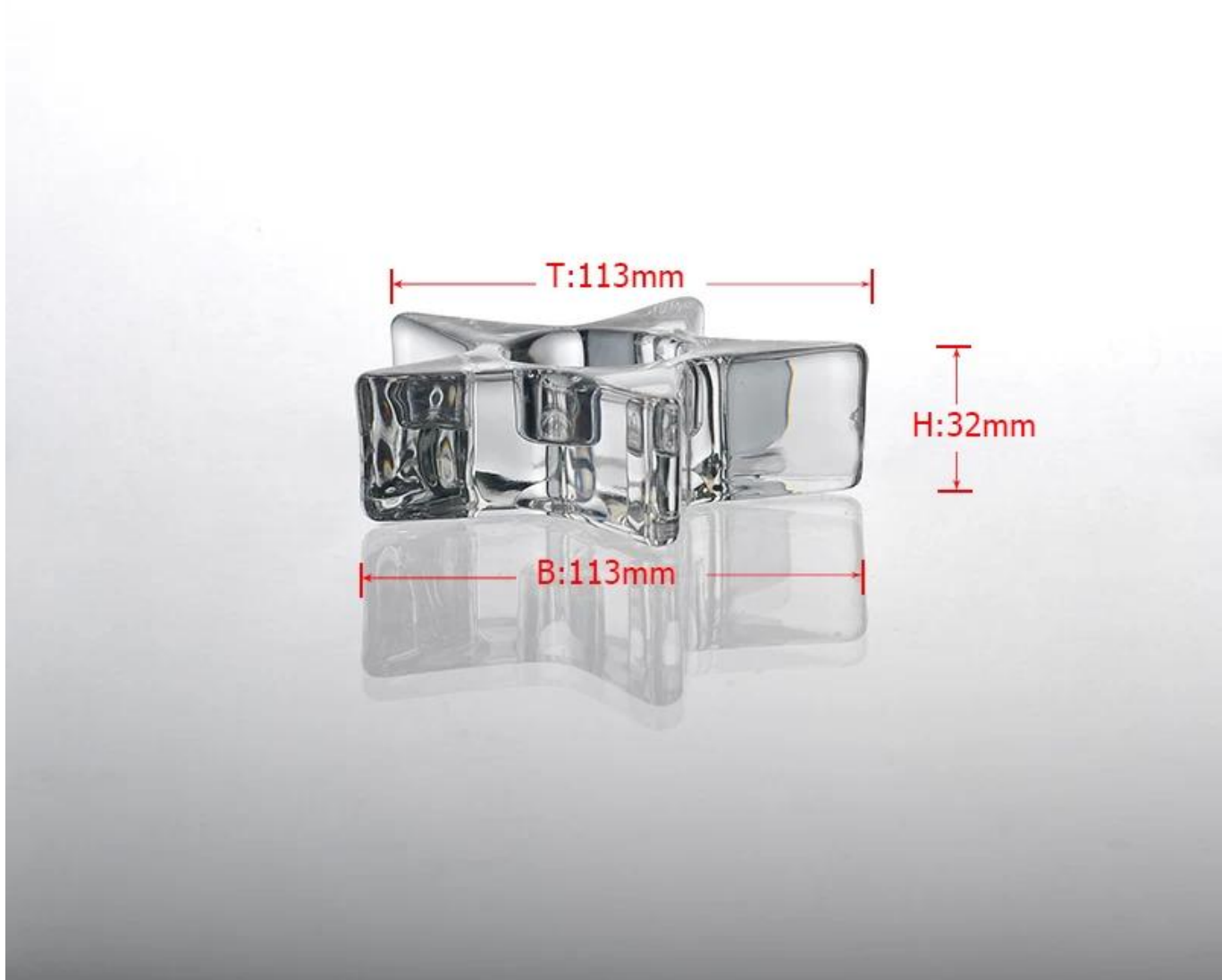

 **Similar Products Link** *Every day is sunny day*



[hot sell tealight glass candle holder](#)

[wholesale tealight glass candle holder](#)

[tealight glass candle holder](#)

Our Company & Sample Room *Every day is sunny day*



Factory Show *Every day is sunny day*





Method of application:

1. Using it under guide of the adult
2. Washing it with clean or boiling water before usage
3. No touching the rim of glass cup,try to take the bottom or the handle of it

Cautions:

1. Beer, red wine, white wine, beverage or hot water not be too full
2. To avoid to hurt your children's hand , please put it in the place where they can't reach
3. Avoid dropping ,Collision and strong impact
4. Not available for microwave oven
5. To prevent it from cracking, do not put it over open fire directly

For more [candle holder](#) or any glassware,
please visit our website: <http://www.okcandle.com/>

Or here may help you know more about us: [FAQ](#)